

# Memo

Type of product			
Date of purchase			
Name		Tel	
Address			

RO800 800GPD Light Commercial

**DRINKING WATER SYSTEM**

## REVERSE OSMOSIS SYSTEM

### USER'S MANUAL

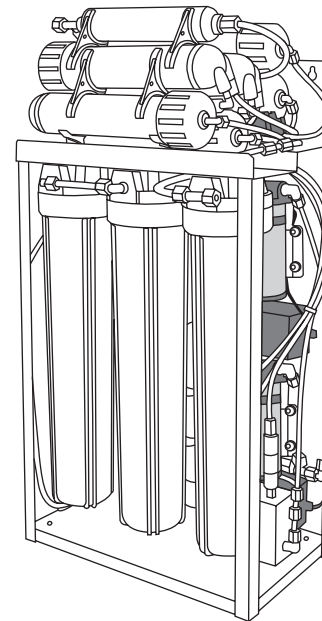

- 01 Introduction of RO
- 02 What is Reverse Osmosis
- 03 Components & Selections
- 04 Cartridge filters
- 05 The parts of RO
- 07 Tubing connection diagram
- 08 Installation diagram
- 13 Change filters
- 14 Change RO membrane
- 15 Operation regulations
- 17 FAQ
- 18 Maintenance checking list
- 19 Memo

**Thank you very much for selecting Pure-Pro Water Corp.**

In order to bring the best use of your system, please read the user's manual carefully before installation and follow the regulations.

**DRINKING WATER SYSTEM**



## FAQ

### Q: What is the guarantee on the PurePro system ?

The PurePro System (excluding filters) is guaranteed for 1 year for material and workmanship. All defective parts will be replaced free within the first year under natural breakdown. The membrane has one year pro-rated guarantee.

### Q: What factors affect the quantity and the quality of the water production?

There are four major variables to consider:

1. **Pressure**-The greater the water pressure, the better water quantity and quality it produced. Water pressure of 60 PSI is ideal.
2. **Temperature**-76°F is the ideal water temperature for R.O. 40°F water will cause the production of R.O. water to fall to half of that at 76°F. The maximum water temperature recommended is 85°F.
3. **Total Dissolved Solids (TDS)**-The higher the amount of dissolved contaminants in the water, the lower the quantity of water produced. A high level of TOTAL DISSOLVED SOLIDS can be overcome with additional water pressure.
4. **Membrane**-Different membranes have different characteristics. Some produce more water than others; some have better contaminant rejection capabilities; some have greater resistance to chemical abrasion for longer life. PurePro system includes RE1812-70 The Thin Film Composite (TFC) membranes combine the best of these characteristics and are considered the finest membrane in the world.

### Q: My RO system is not making any water. What should I do?

1. Make sure you plug in electricity.
2. Check the water supply. Make sure it's on.
3. Check if pumps work well.

If none of above occur, please contact a technician at the nearest shop for assistance.

### Q: Why can't my water storage tank make enough water?

1. Switch off the water supply and turn on the faucet.
2. Check the water flow from the faucet. If water stop coming out, check the water storage tank.

Water tank still has water: the tank water pressure is under regular water pressure → give pressure to the tank.

## What is reverse osmosis

Reverse osmosis was originally designed to make sea water drinkable for the navy. It is ideal for anyone on a low sodium diet. An R.O. membrane has a pore size much smaller than bacteria virus, or the cryptosporidium parasite. When functioning properly it will remove all microorganisms from tap water and produce sterile water. Reverse osmosis is the reversal of the natural flow of osmosis. In a water purification system, the goal is not to dilute the salt solution, but to separate the pure water from the salt and other contaminants. When the natural osmotic flow is reversed, water from the salt solution is forced to pass through the membrane in the opposite direction by application of pressure-thus the term REVERSE OSMOSIS. Through this process, we are able to produce pure water by screening out the salts and other contaminants.

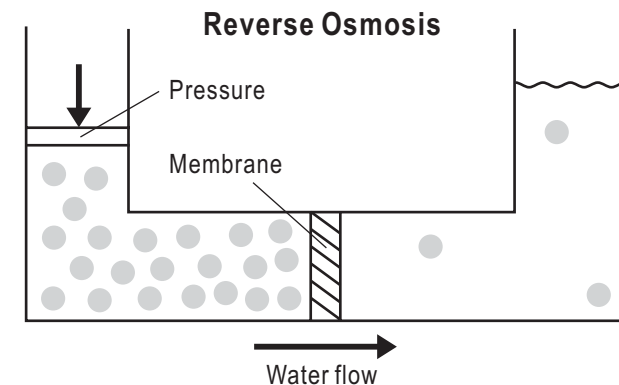

## Components & Selections

### ◆ Components

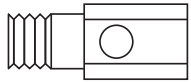

Feed water connector

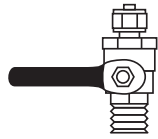

3/8 deliver-valve

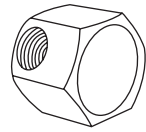

Tank ball valve



RO membrane x 8

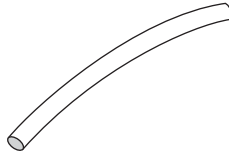

7 meters tubing white

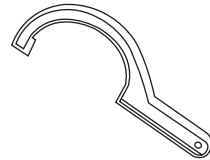

Housing wrench C-type

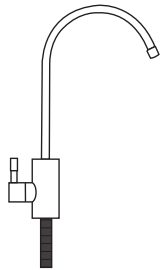

Long reach faucet

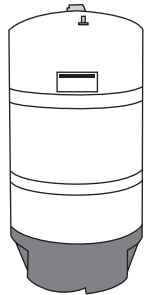

20G water storage tank

### ◆ Selections

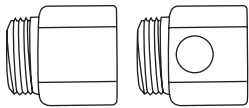

1. 6/8 hot & cold water deliver-valve

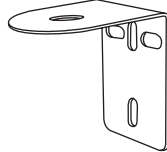

2. standing faucet bracket

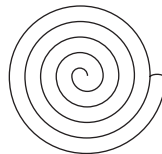

3. 3/8 extended RO tubing white

## Operation regulation

- A. With everything connected, turn on the water check for leaks.
- B. Make sure the storage tank shut-off valve is "OFF". Open the sink top faucet.
- C. Within a few minutes (up to 15) the water will start to run from the faucet slowly.
- D. Let the water run for at least 30 minutes. This flushes the carbon filters on first time use.
- E. After initial flushing, open the shut-off valve on the tank and close the sink top faucet.
- F. Tank will now full of water (usually 2 to 3 hours) after the tank has filled. Open the sink top faucet and drain all water until the storage tank is empty and there is only a small flow from the sink top faucet. \*\*\* DO NOT USE FIRST TANK OF WATER.\*\*\*
- G. Close the sink top faucet. The system is now ready for use.
- H. Change filters regularly every 6 to 12 months and have the membrane checked annually.

### Caution

1. Do not use hot water (over 45°C)!
2. Do not freeze the machine!
3. Switch off electricity and water source if away for more than 5 days, and drain out pure water.

## Operation regulation

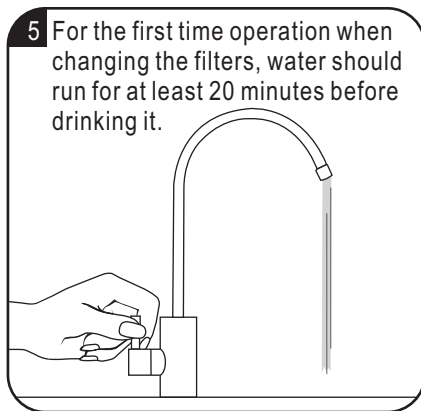
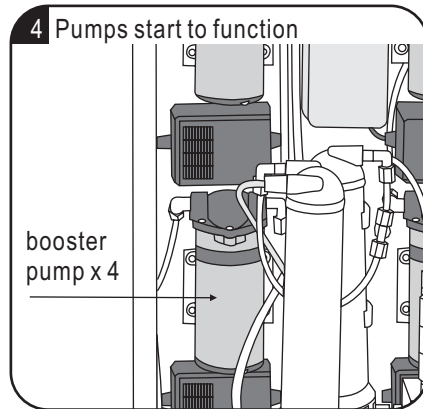
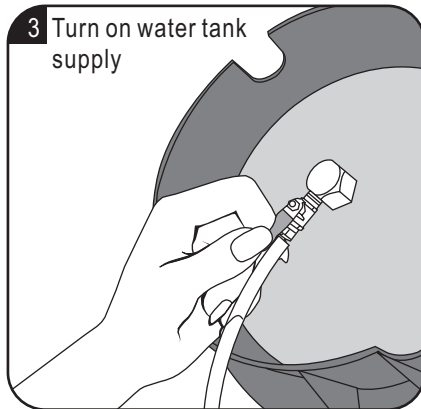
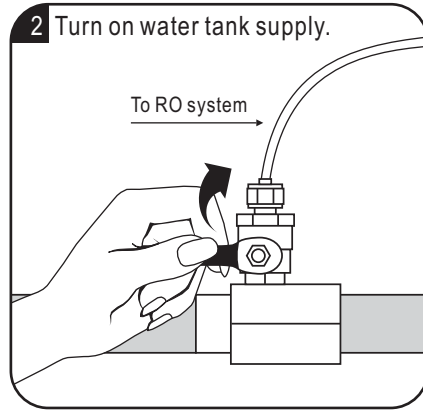
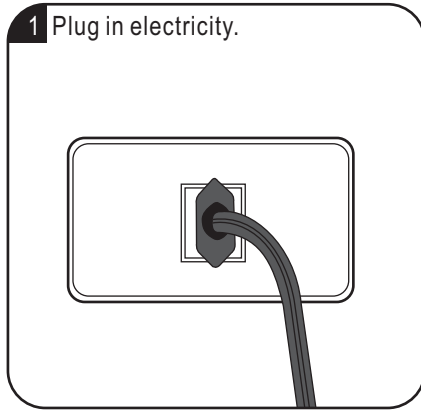

RO800 800GPD Light Commercial

**PUREPRO**  
DRINKING WATER SYSTEM

## Cartridge Filters

Cartridge Filters	Filter Description	Service Life
<p><b>Stage 1</b> 20" length 5 micron Spun-polypropylene Sediment Filter</p>	<p>This 5micron sediment filter is made of 100% pure polypropylene fibers. High capacity filter removes dusts, particles and rusts.</p>	3 Months
<p><b>Stage 2</b> 20" length Granular Activated Carbon Filter</p>	<p>This granular activated carbon filter is composed of high-performance activated carbon that removes free chlorine, odor, organic contaminants, pesticides and chemicals that contributed to taste and odor.</p>	3 Months
<p><b>Stage 3</b> 20" length Block Carbon Filter</p>	<p>This block carbon filter is composed of high-performance carbon that removes free chlorine, odor, organic contaminants, pesticides and chemicals that contributed to taste and odor.</p>	3 Months
<p><b>Stage 4~11</b> 100GPD TFC membrane 8 pcs</p>	<p>Made in USA. High rejection TFC type membrane with the capacity of producing 80 gallons per day. This membrane removes the following hard water contaminants that may be present in your water: lead, cooper, barium, chromium, mercury, sodium, cadmium, fluoride, nitrite, nitrate, and selenium.</p>	1 Year
<p><b>Stage 12</b> 12" Inline Post Carbon Filters</p>	<p>NSF approved. This post carbon filter is designed to improve taste. It removes any residual impurities and odors from the tank and provides a finer conditioning of pure water.</p>	1 Year

RO800 800GPD Light Commercial

**PUREPRO**  
DRINKING WATER SYSTEM

# The parts of RO800

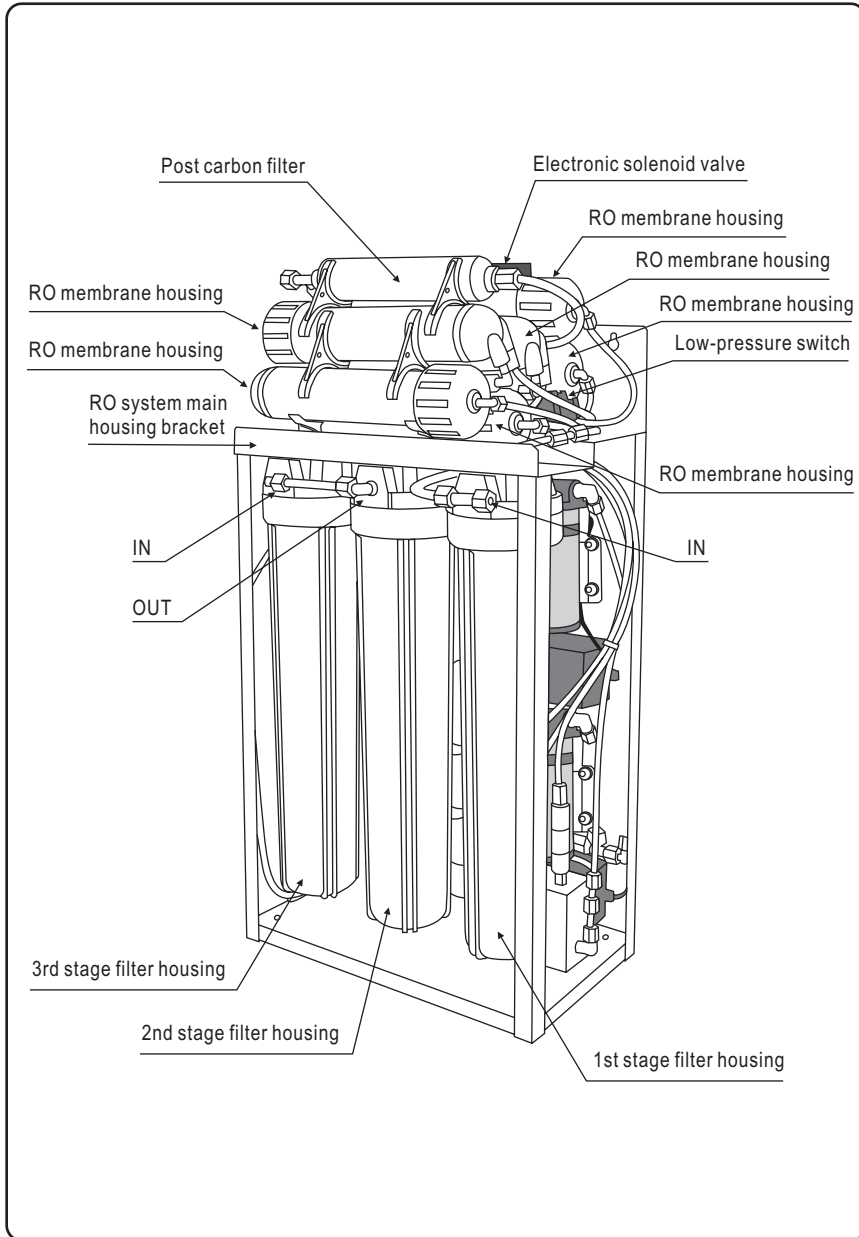

RO800 800GPD Light Commercial

# Change membrane

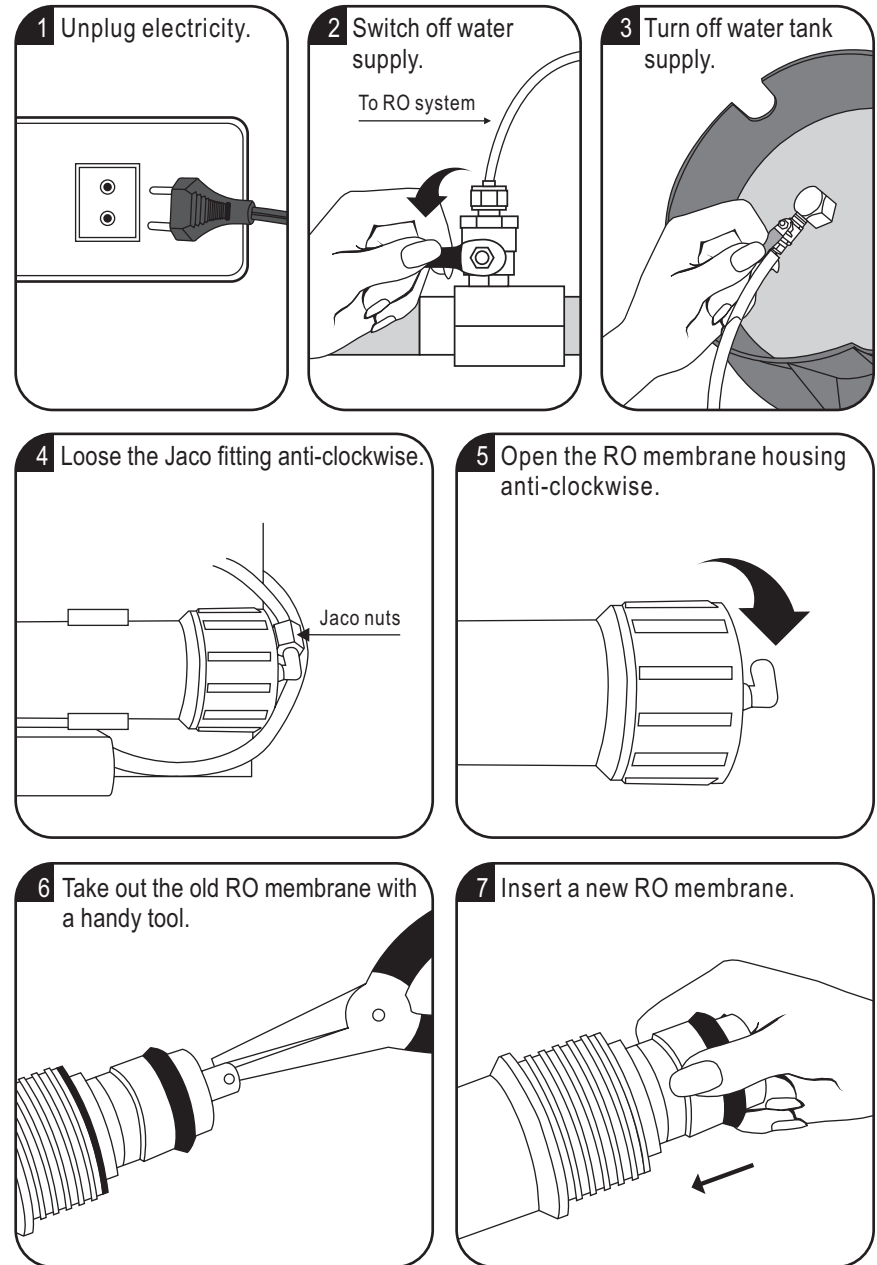

RO800 800GPD Light Commercial

## Change filters

- 1** Have a C-type housing wrench ready.

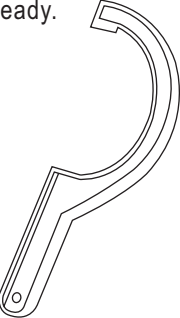

- 2** Switch off water supply.

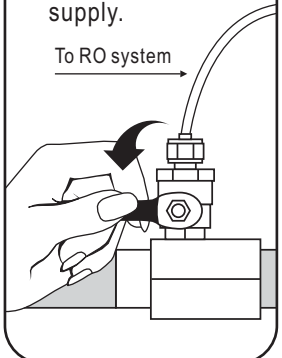
To RO system

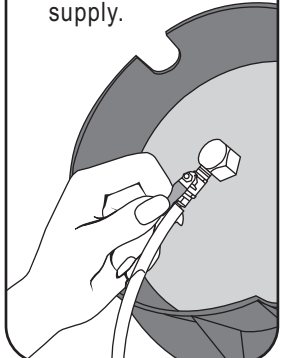
- 3** Turn off water tank supply.

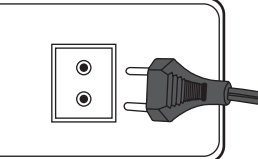

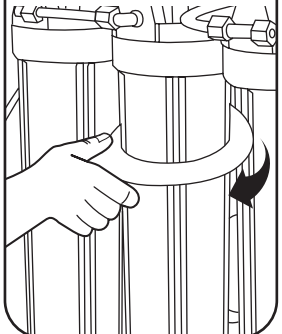
- 4** Unplug electricity.

- 5** Open the housings clockwise.

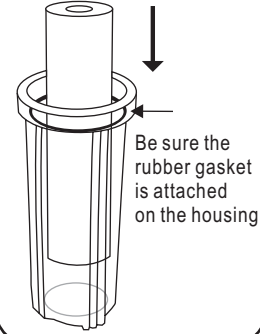
- 6** Insert new filter.

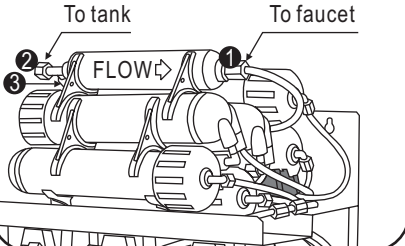

Be sure the rubber gasket is attached on the housing
- 7** Loosen the fitting nuts at point 1, 2, 3. Take out the jaco fittings, and seal it up with the Teflon tape again. Replace the new pre-filters.



To tank      To faucet

FLOW →
- 8** After changing filters, let water run for about 15 minutes to clear the filters.

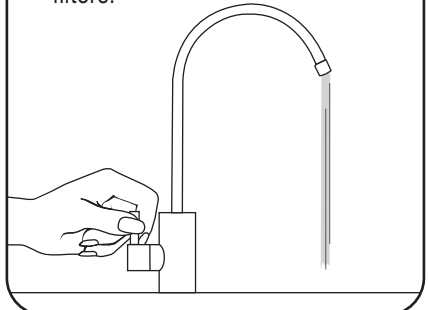

RO800 800GPD Light Commercial

## The parts of RO800

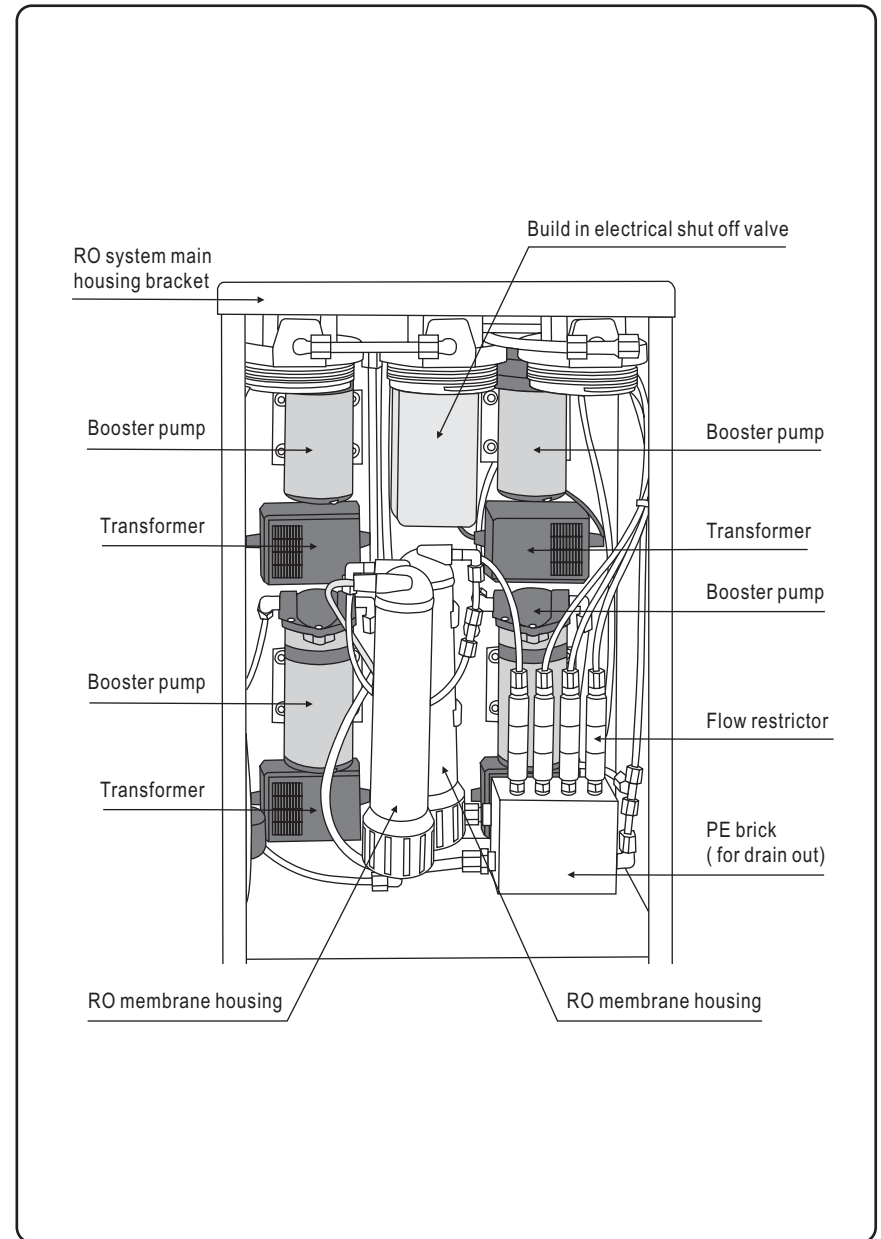

RO800 800GPD Light Commercial

## Tubing connection diagram

- 1** In
- 2** To water storage tank
- 3** Drain out
- 4** To faucet

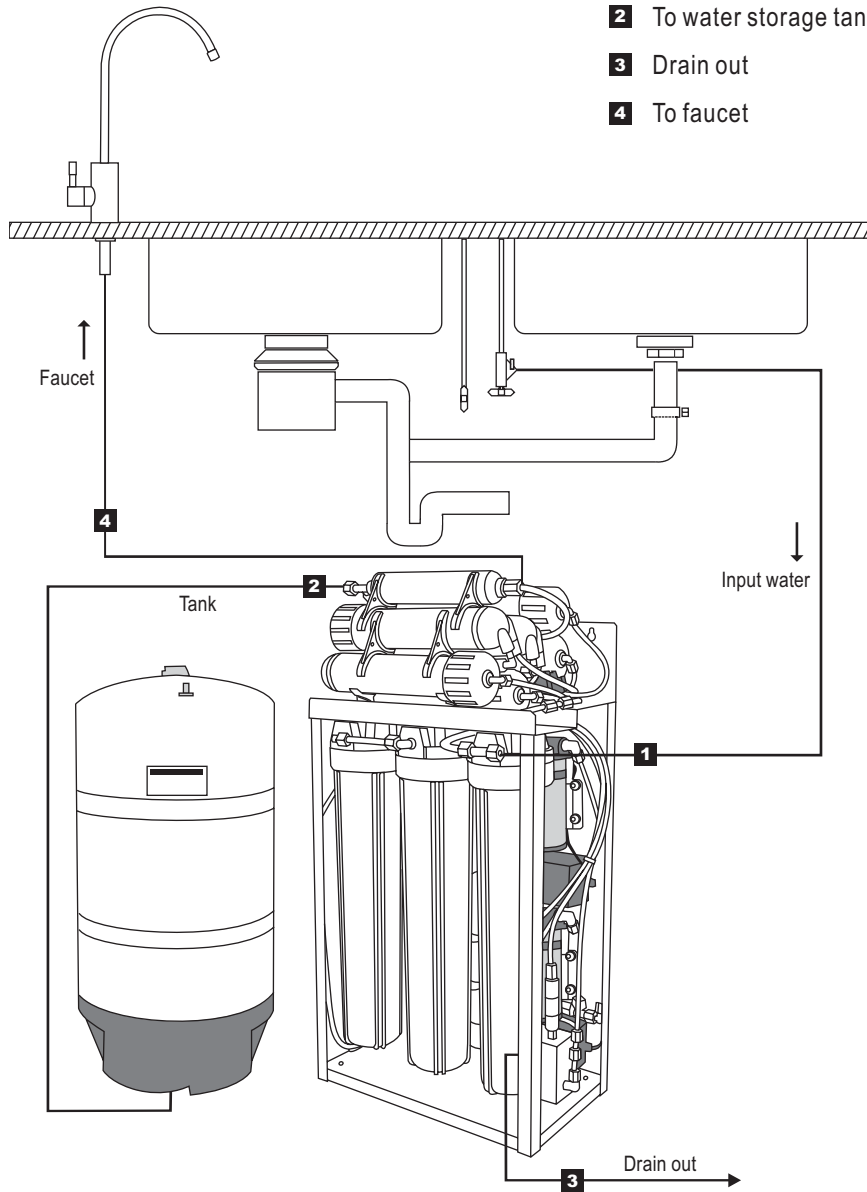

RO800 800GPD Light Commercial

## Installation diagram

11. Take tubing white. Wear the concave type screw on tubing white and insert the tubing shroud as shown in the picture. Connect the tubing top with the faucet end. Then connect the tubing end to the last stage filter (as point 4 on page 07)

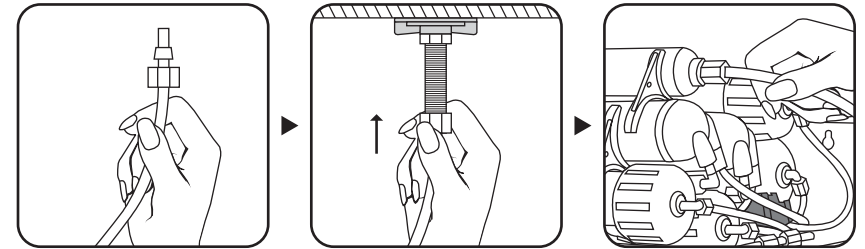

12. Make sure that you complete No. 1 to No. 11. If so, switch on water supply and plug in electricity.

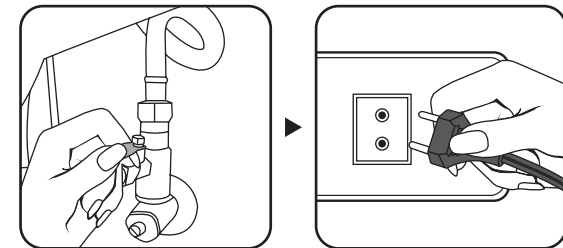

PS. Do not use drink water from the first made water in the tank.

RO800 800GPD Light Commercial



## Installation diagram

10. Take out the faucet and its components. Install the faucet and the rubber gasket to the kitchenware table. Install the rest of component as shown in the picture.

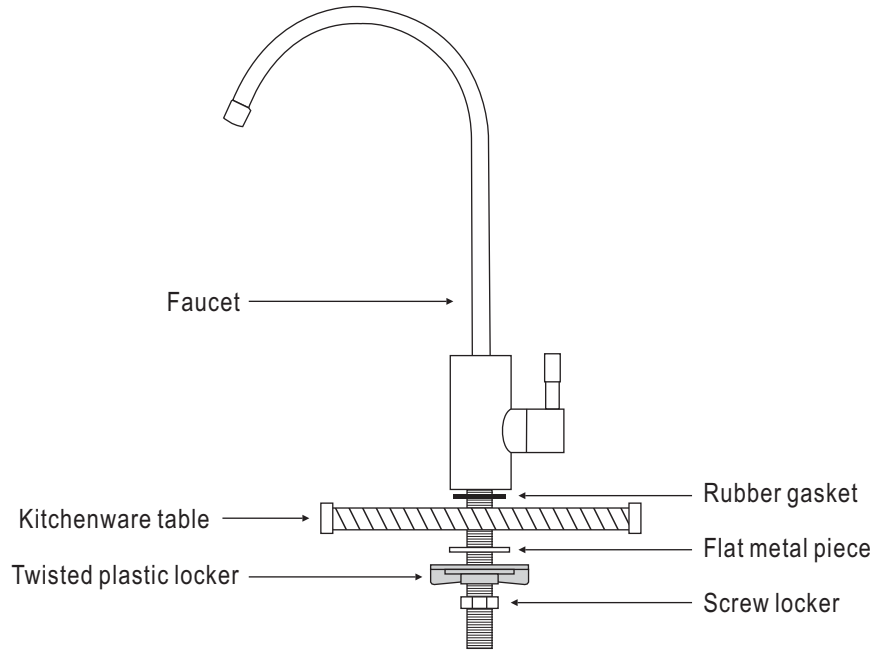

PS. To suit your kitchenware table, you can choose to have twisted plastic locker or screw locker to be installed for your faucet.

## Installation diagram

1. Loosen the fitting nuts and the cap from the RO membrane housing as shown in the picture. Unpack the RO membrane and insert it to its housing (rubber gasket towards to the open end). When completed, tighten up the cap with the RO membrane housing and the jaco fittings.

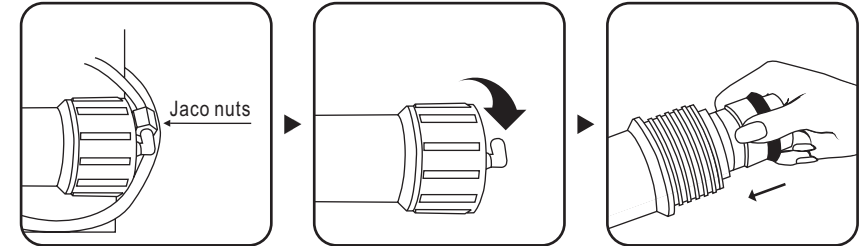

2. Turn off the water supply. Loosen the stainless steel pipe connector.

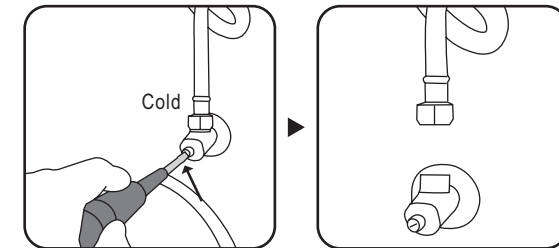

3. Get feed water connector and connect it to the stainless steel pipe as in the picture 2.

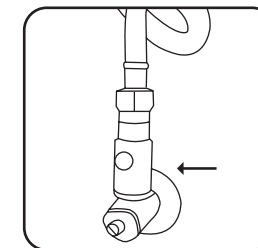

## Installation diagram

4. Get deliver valve and seal it with Teflon tape for 14 circles. Then connector it with the feed water connector.

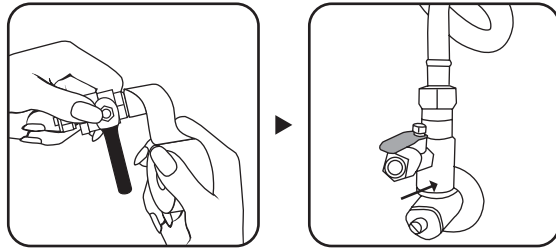

5. Get tubing white, connect it with deliver valve and the inlet water supply (as point 1 on page 07)

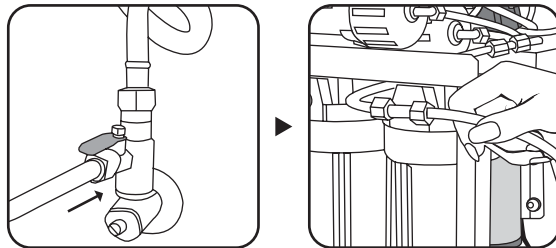

6.a. Unpack water storage tank. Take tank ball valve and deliver valve. Seal the female jaco fitting as attached on the water tank with Teflon tape for 15 circles. (picture 1). Take tank ball valve and tighten it up with the female jaco fitting.

b. Use Teflon tape again to seal the another deliver valve. (picture 2). Then tighten it up with the tank ball valve.

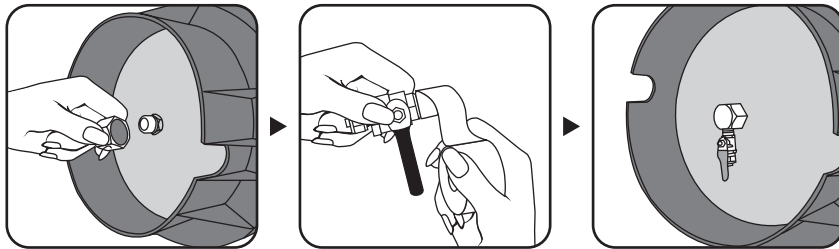

RO800 800GPD Light Commercial

## Installation diagram

7. Take tubing white, connect it to the deliver valve and the inlet water to storage tank (as point 2 on page 07)

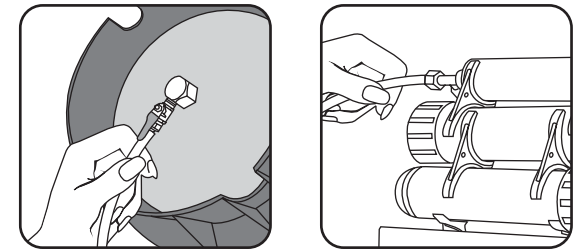

8. Take tubing white again, connect it with the drain out (as point 3 on page 07)

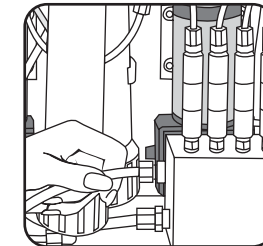

9. Use an electric drill and drill an approximately 1 cm hole through the kitchenware table.

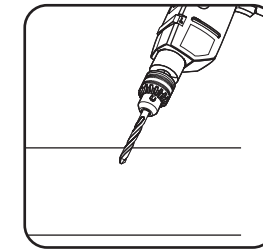

RO800 800GPD Light Commercial